

# Assembly & Installation

# Dimension Stele LINXX

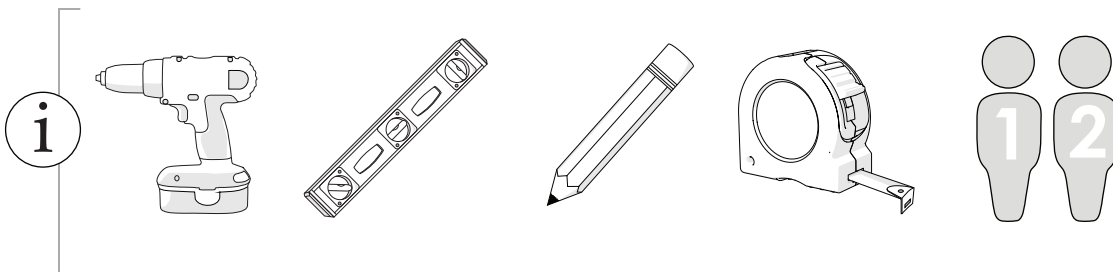

DMOL - DMIB - DMOR

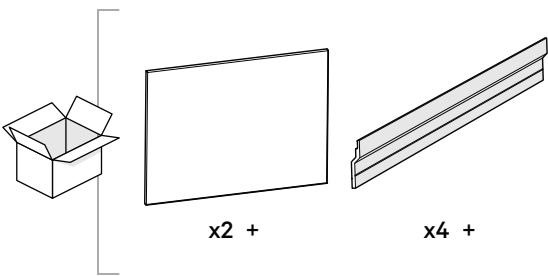
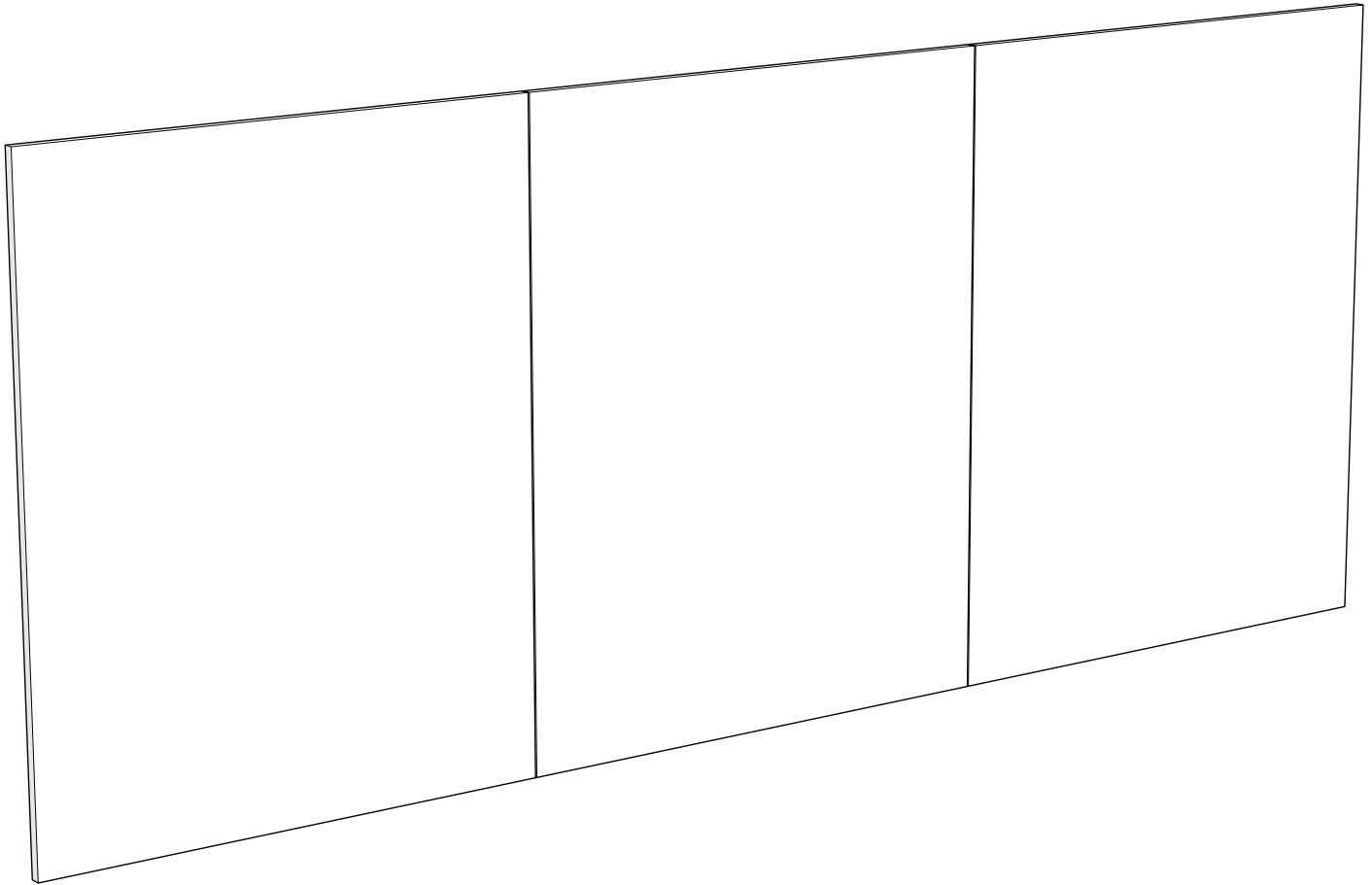

# Assembly & Installation

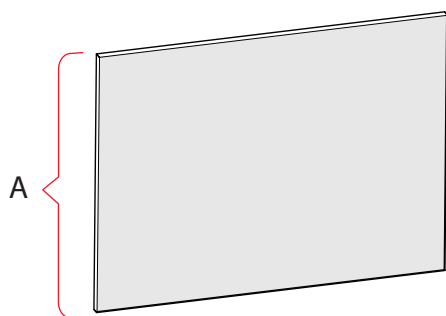
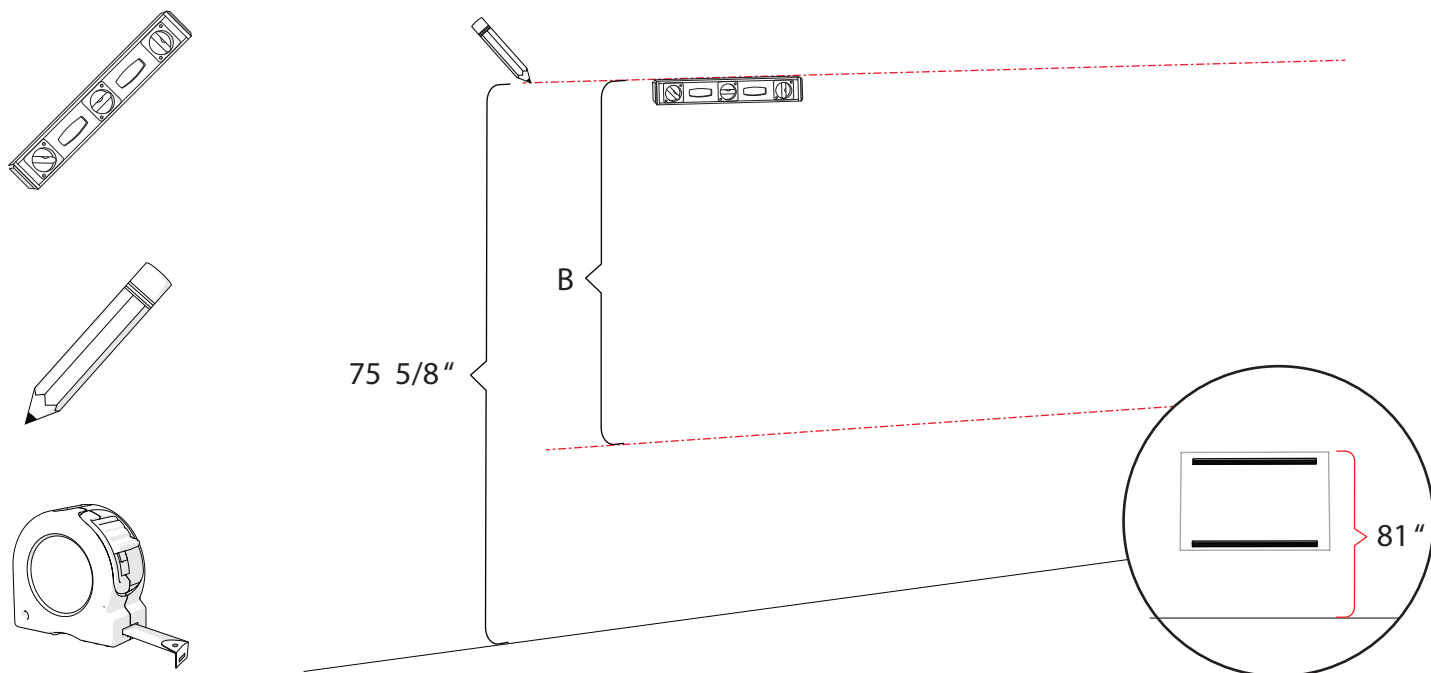

$$(B) = (A) - 13 \frac{7}{16} "$$

# Assembly & Installation

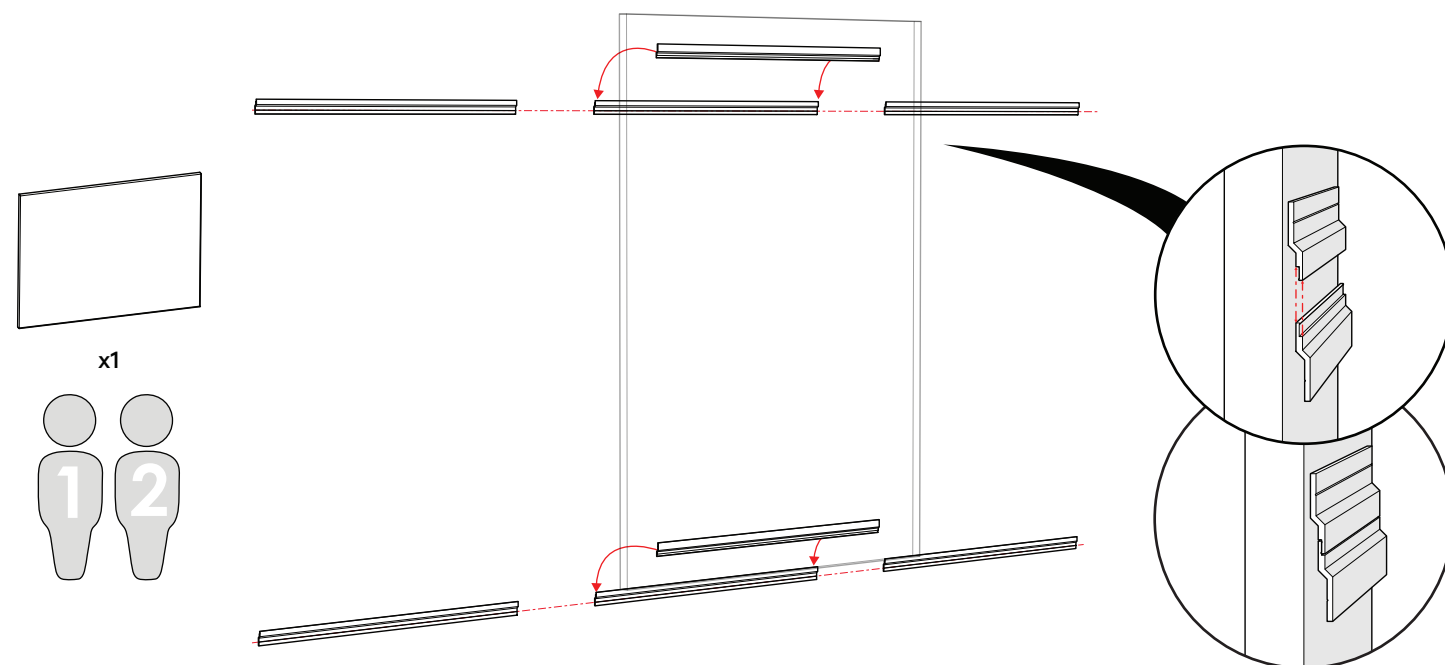
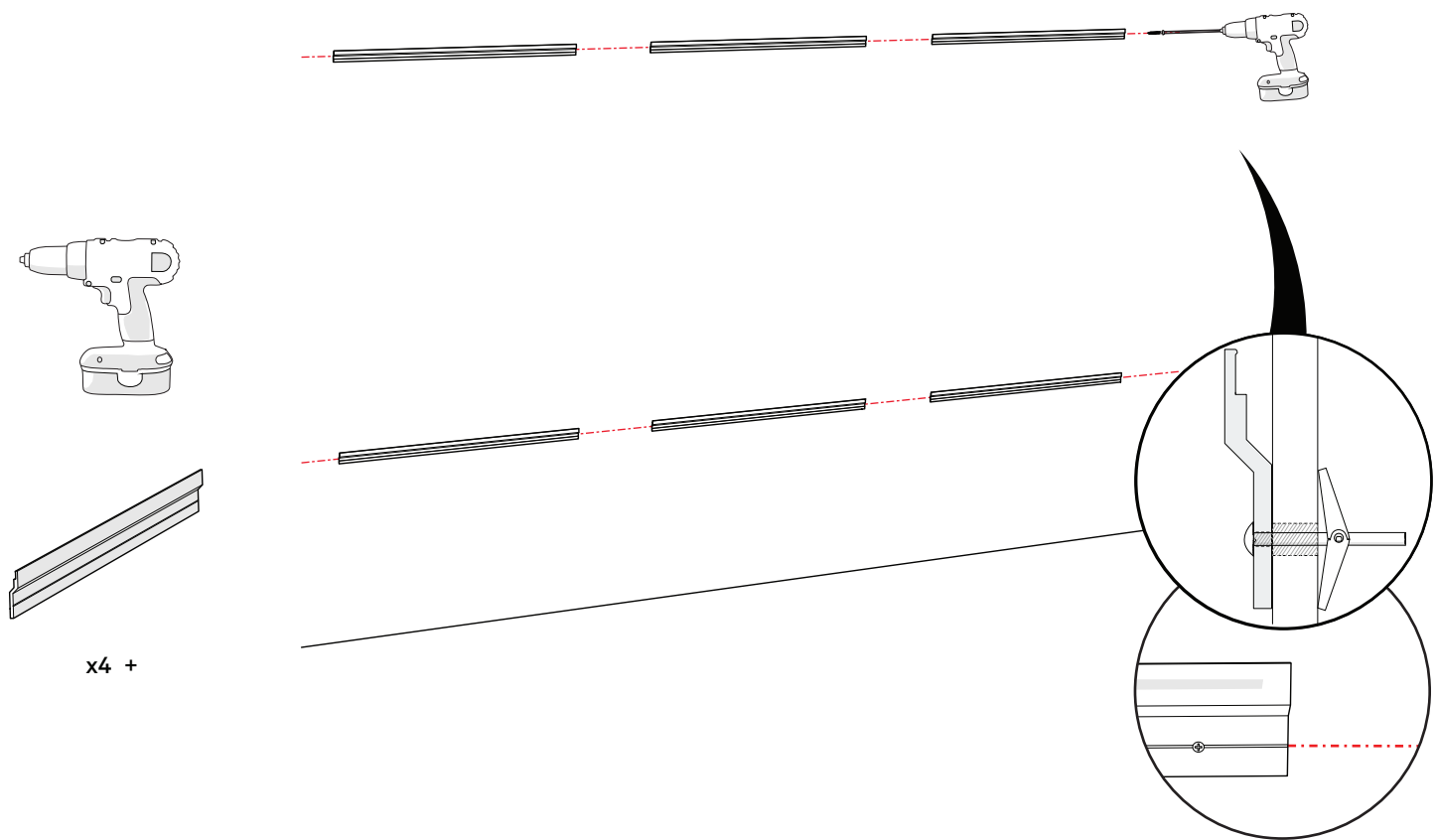

# Assembly & Installation

